

D 4 19.1 Y

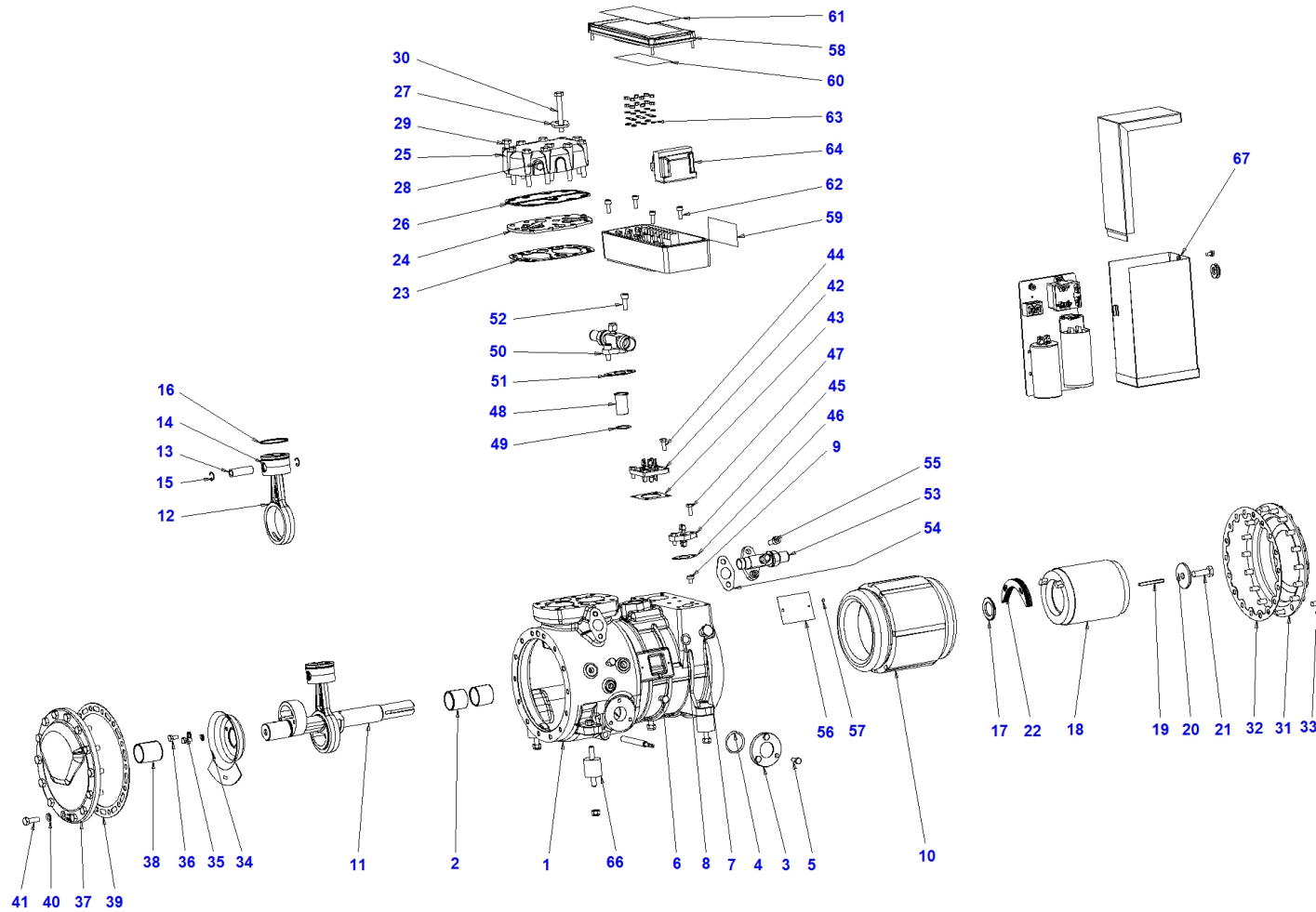

Pos.	Code	Description	Quantity	Note	Notice:
1	S2481001AA	Compressor body	1		
2	S1501013	Main friction bearing	2		
3	SOS1	Oil sight glass	1		
4	S3131OR	O-ring for oil sight glass	1		
5	TE1006016	Screw M6x16 UNI5739	3		
6	S1251130	Plug 1/8 NPT	2		
7	S1451130	Plug 1/4" gas ISO 228/1	1		
8	S1351056	Gasket	1		
9	TS4006008	Screw M6x8 ISO 7045	1		
10	RS07AS1	Stator 230-400 / 3 / 50 DOL	1		
11	S2481002AA	Shaft	1		
12	S2471003AA	Connecting rod	2		
13	S4031005A	Piston pin	2		
14	S4031004	Piston	2		
15	S1251149	Circlip	4		
16	S4034001	Fosfating ring	2		
17	S2481011	Thrust collar	1		
18	RR06BS	Rotor	1		
19	S1451063	Key 5x5x55	1		
20	S2481045	Washer	1		

Pos.	Code	Description	Quantity	Note	Notice:
21	TE1010040	Screw M10x40 UNI5739	1		
22	S1251017	Counterweight	11		
23	S2451031	Gasket valve plate - body	1		
24	S2451026-HL	Valve plate	1		
25	S2451007AA	Head	1		
26	S2451032	Gasket valve plate - head	1		
27	V0001532	Lifting eyebolt	1		
28	S1251130	Plug 1/8 NPT	1		
29	TE1208080	Screw M8x80 UNI5737	10		
30	TE1208085	Screw M8x85 UNI5737	1		
31	S2451010AA	Suction flange	1		
32	S1251034C	Suction flange - body gasket	1		
33	TE1208060	Screw M8x60 UNI5737	18		
34	S2351008	Oil splashing disc	1		
35	RO2006011	Washer 6x10 UNI 1751A	2		
36	TE1006012	Screw M6x12 UNI5739	2		
37	S2481009AA	Flange	1		
38	S2481013-A	Main friction bearing	1		
39	S2481033C	Flange gasket	1		
40	S1451056	Gasket	1		

Pos.	Code	Description	Quantity	Note	Notice:
41	TE1008022	Screw M8x22 UNI5739	14		
42	T00EC02A	Connections plate	1		
43	S1251043	Connections plate gasket	1		
44	TE1006016	Screw M6x16 UNI5739	4		
45	T00EC05	Thermistor terminal	1		
46	S1251036C	Thermistor gasket	1		
47	TE1006016	Screw M6x16 UNI5739	2		
48	S2481038-A	Suction strainer	1		
49	S2481055	Suction strainer gasket	1		
50	T00VRS034041	Valve 1' 1/8	1		
51	S2481058	Valve gasket	1		
52	TC2408020	Screw M8x20 UNI5931	2		
53	T00VRS032041	Valve 3/4	1		
54	S2481058	Valve gasket	1		
55	TC2408020	Screw M8x20 UNI5931	2		
56	ML_D	Nameplate	1		
57	RI1025035	Rivet	2		
58	S249A039	Terminal box	1		
59	M199-00	Cablepress holes-making adhesive scheme	1		
60	M053-00	Starting drawing	1		

Pos.	Code	Description	Quantity	Note	Notice:
61	M066-00	Security operation drawing	1		
62	TC2006016	Screw M6x16	4		
63	SK261100	Staple bars kit	1		
64	ECA01A	Electronic module 220V AC	1		
66	SK205010	Rubber vibration absorber kit	1		
	S403A004	Piston kit	1		
	SK0600	Gasket kit	1		
	SK100320	Valve kit	1		
	SK100340	Valve kit	1		
	SK131305	Connecting rod/piston kit	2		
	SK140100	Friction bearing kit	1		
	SK170100	Oil sight glass kit	1		
	SK180300	3 ph terminal box kit	1		
	SK230700	Complete electric motor - 230-400 / 3 / 50 DOL	1		
	SK24802	Valve plate kit	1		
	SK260200	3 ph electric connections kit	1		
	SK260300	3 ph thermistor connectors kit	1		