

User Guide

# Capacity controller AK-PC 530

ADAP-KOOL® Refrigeration control systems

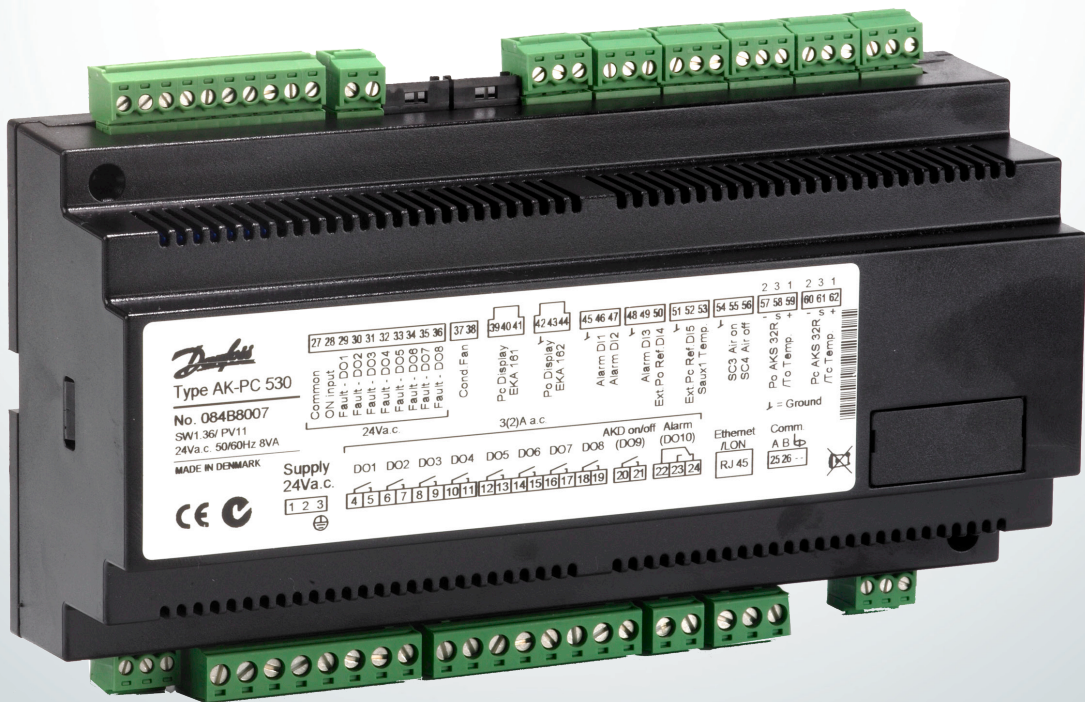

## Introduction

### Application

The controller is used for capacity regulation of compressors or condensers in small refrigerating systems.

Numbers of compressors and condensers can be connected, as required.

There are eight outputs and more can be added via an external relay module.

### Advantages

- Patented neutral zone regulation
- Many possible combinations for compressor constellations
- Sequential or cyclic operation
- Possibility of suction pressure optimisation via the data communication

### Regulation

Regulation is based on signals from one pressure transmitter for the compressor regulation and one pressure transmitter for the condenser regulation plus one temperature sensor for the air temperature before the condenser.

The two pressure transmitters can be replaced by two temperature sensors when regulation has to be carried out on brine systems.

- Pressure regulation P0 (pack)
- Temperature regulation Sx (chiller)
- Pressure regulation Pc (pack / chiller)
- Pressure regulation with variable reference (Sc3)

### Functions

- Relays for compressor and condenser regulation
- Voltage output for capacity regulation of condenser
- Status inputs. An interrupted signal indicates that the safety circuit has been activated and the respective circuit stopped
- Contact inputs for indication of alarms
- Contact inputs for displacement of references or for indication of alarms
- Alarm relay
- External start/stop of regulation
- Possibility of data communication

### Operation

All operation takes place either via data communication or via connection of a display type EKA 164 or EKA 165.

### Combinations

The controller has ten relay outputs two of which have been reserved for the alarm function and for the "VLT start/stop" function.

For a start relays are reserved for compressor capacities starting from DO1, DO2, etc.

The remaining relays up to and including DO8 will then be available for fans. If more are required, one or more relay modules type EKC 331 with max. eight steps can be connected. The signals to these modules are to be taken from the controller's analog output. Another solution could be that the fan speed is controlled via the analog output and a frequency converter.

If the alarm function and the "AKD start/stop" function are left out, all ten relay outputs may be used for compressors and fans (but max. eight for compressors and max. eight fans).

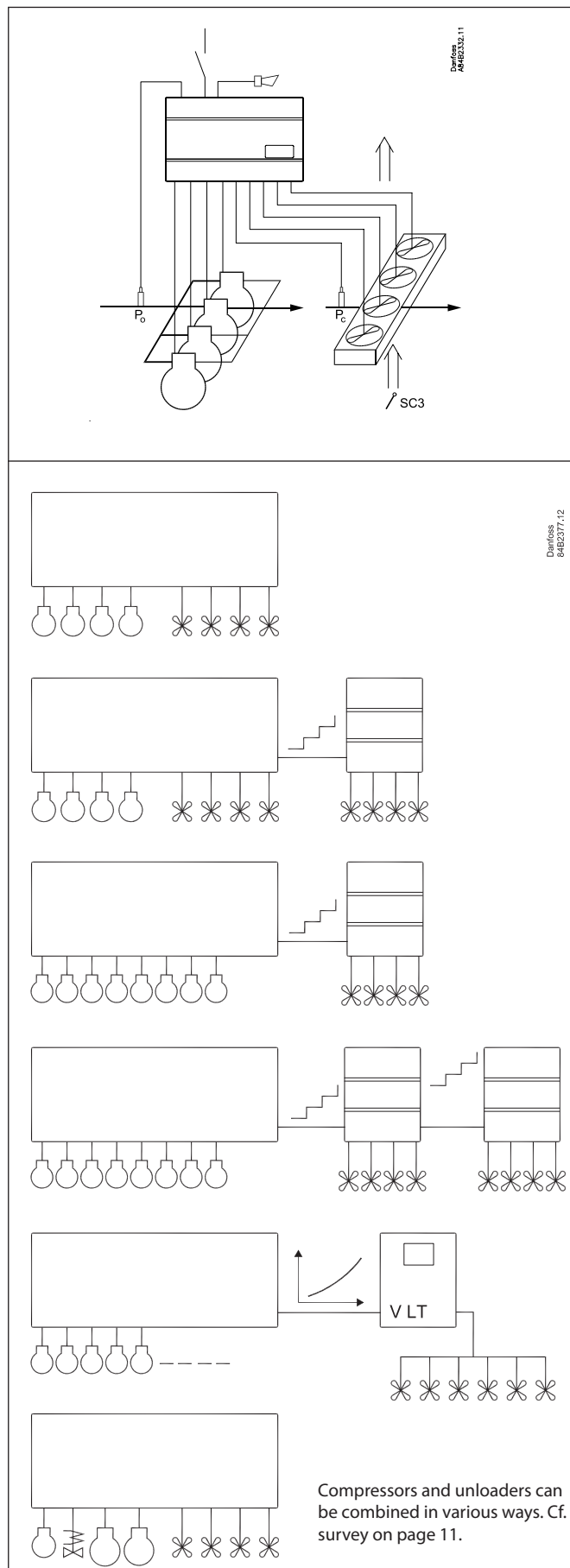

## Function

### Capacity regulation

The cut-in capacity is controlled by signals from the connected pressure transmitter/temperature sensor and the set reference. Outside the reference a neutral zone is set where the capacity will neither be cut in nor out.

Outside the neutral zone (in the hatched areas named +zone and -zone) the capacity will be cut in or out if the regulation registers a change of pressure "away" from the neutral zone. Cutin and cutout will take place with the set time delays.

If the pressure however "approaches" the neutral zone, the controller will make no changes of the cut-in capacity.

If regulation takes place outside the hatched area (named ++zone and --zone), changes of the cut-in capacity will occur somewhat faster than if it were in the hatched area.

Cutin of steps can be defined for either sequential, cyclic, binary or "mix & match" operation.

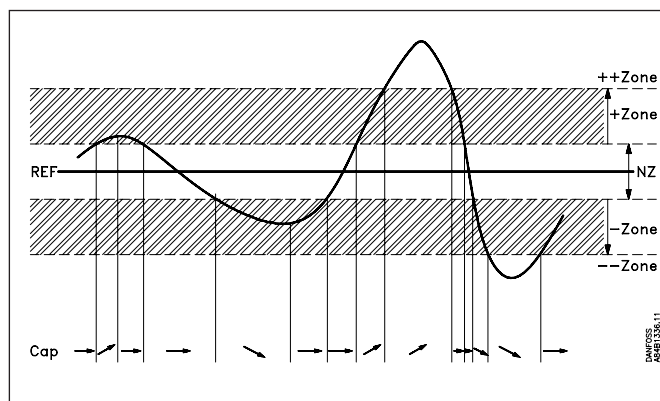

#### Sequential (first in - last out)

The relays are here cut in in sequence – first relay number 1, then 2, etc.

Cutout takes place in the opposite sequence, i.e. the last cut-in relay will be cut out first.

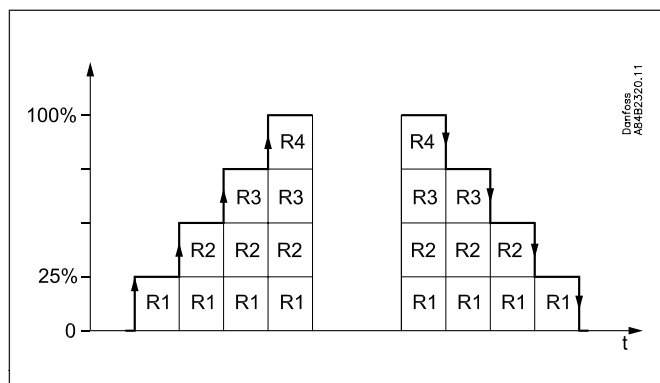

#### Cyclic (first in - first out)

The relays are coupled here so that the operating time of the individual relays will become equalised.

At each cutin the regulation scans the individual relays' timer, cutting in the relay with least time on it.

At each cutout a similar thing happens. Here the relay is cut out that has most hours on the timer.

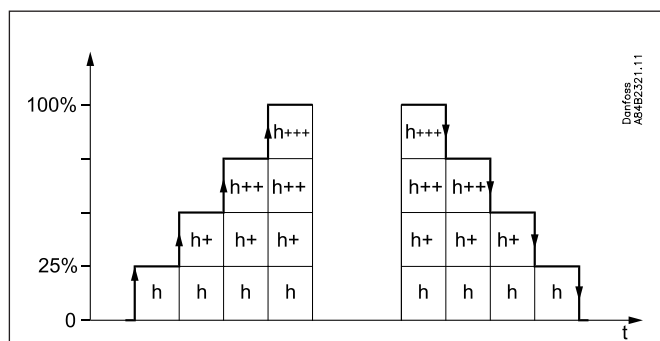
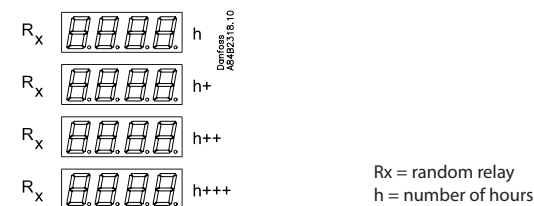

If capacity regulation is carried out on two compressors with one unloader each, the following function can be used:

Relays 1 and 3 are connected to the compressor motor.

Relays 2 and 4 are connected to the unloaders.

Relays 1 and 3 will operate in such a way that the operating time for the two relays will become equalised.

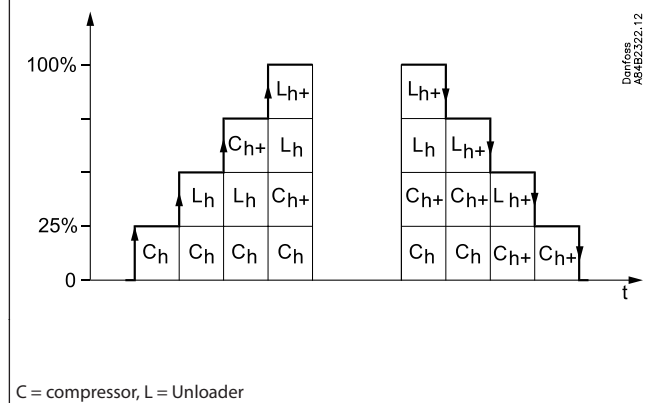
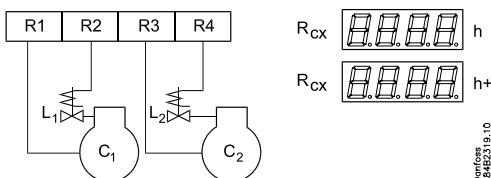

## Suvey of functions

The total function content is shown below – not all functions are present at the same time. The setting of o61 determines which functions are present.

The menu overview on page 14 shows the various functions and settings.

Function	Parameter	Parameter by operation via data communication
<b>Normal display</b>		
If the two displays are mounted: P0 will be shown on EKA 165 (the one with buttons) Pc will be shown on EKA 163. Both readouts will be in temperature or in bar.		P0 °C or P0 b Pc °C or Pc b
<b>Compressor regulation reference</b>		<b>Compressor control</b>
<b>P0 setpoint</b> Regulation is based on the set value plus an offset, if applicable. An offset can be created from night setback r13 and/or from a system units override function.	r23	P0Set Point °C / P0Set Point b
<b>Offset</b> The set reference may be displaced with a fixed value when a signal is received at the DI4 input or from the function "Night setback" (r27). (Cf. also Definition of DI4 input).	r13	Night offset
<b>Night setback</b> <b>OFF:</b> No change of the reference <b>ON:</b> Offset value forms part of the reference	r27	NightSetBack
<b>Reference</b> The regulation reference is shown here	r24	P0 ref. °C / P0 ref. b
<b>Set point limitation</b> With these settings the setpoint can only be set between the two values. (This also apply if regulation with displacements of the reference).		
Max. permissible setpoint value.	r25	P0RefMax °C / P0RefMax b
Min. permissible setpoint value.	r26	P0RefMin °C / P0RefMin b
<b>Neutral zone</b> There is a neutral zone around the reference. See also page 3.	r01	Neutral zone
<b>Correction of pressure measurement</b> An offset adjustment of the registered pressure can be made.	r04	AdjustSensor
<b>Unit</b> Here you can select whether the display is to indicate in SI units or US units. <b>0:</b> SI (°C / bar) <b>1:</b> US (°F / psig)	r05	(In AKM only SI (bar and °C) is used, whatever the setting)
<b>Start/stop of refrigeration</b> With this setting the refrigeration can be started and stopped. Start/stop of refrigeration may also be performed with an external contact function connected to the input named "ON input". (The input <b>must</b> be wired).	r12	Main Switch
<b>Condenser regulation reference</b>		<b>Condenser control</b>
<b>Pc setpoint</b> Regulation is based on the set value plus an offset, if applicable. An offset can be created via the "r34" function and/or from a system units override function.	r28	PcSet Point °C / PcSet Point b
<b>Offset</b> The set reference may be displaced with a fixed value when a signal is received at the DI5 input. (Cf. also Definition of DI5 input).	r34	PcRefOffset
<b>Pc reference variation.</b> See also page 22 Regulation with setting 1 (or 2 if the reference is to vary with the outdoor temperature) will give the best regulation if the system is in balance. But if a lot of condenser steps are cut in and out and the compressor capacity often becomes low, it will be necessary to select setting 3 instead (or 4, if there is regulation with the outdoor temperature). (Settings 3 and 4 will generally be preferable if a Pc-offset at max. compressor capacity can be accepted). <b>1:</b> No change of the reference. Regulation based on set setpoint. And offset with the DI5 function is allowed. <b>2:</b> Outdoor temperature forms part of the reference. The outdoor temperature is measured with Sc3. When the outdoor temperature drops one degree, the reference is lowered one degree. Here is offset with the DI5 function not allowed. At DI5 signal the reference will change to the set setpoint. Setting 1 and 2 operate with a PI regulation, but if the system is unstable and the PI regulation not satisfactory the I element may be left out, so that the controller will be with P regulation only. <b>3:</b> As 1, but with P regulation (xp-band) <b>4:</b> As 2, but with P regulation (xp-band)	r33	Pc mode

<b>Condenser reference</b> The regulation reference is shown here.	r29	Pc ref. °C / Pc ref. b
<b>Set point limitation</b> With these settings the setpoint can only be set between the two values. (This also applies to regulations where the Xp band lies above the reference). Max. permissible setpoint value.	r30	PcRefMax °C / PcRefMax b
Min. permissible setpoint value.	r31	PcRefMin °C / PcRefMin b
<b>Correction of pressure measurement</b> An offset adjustment of the registered pressure can be made.	r32	AdjustSensor
<b>Dimensioning temperature Dim tm</b> The mean temperature difference across the condenser at maximum load (tm difference at max. load). This is the temperature difference between the air and condensing temperature.	r35	Dim tm K
<b>Dimensioning temperature Min tm</b> The mean temperature difference across the condenser at the lowest relevant compressor capacity (tm difference at min. load). This is the temperature difference between the air and condensing temperature.	r56	Min tm K
<b>Reading your P0</b> This is where you can see the actual pressure that is being measured by the pressure transmitter. The value is part of the regulation, since the regulation signal for capacity regulation originates from the pressure transmitter. The value is part of the frost protection regulation, since the regulation signal for capacity regulation originates from the temperature sensor.	r57	P0°C / P0 b
<b>Reading your T0</b> This is where you can see the actual pressure being measured by the sensor chosen for capacity regulation (the sensor is defined in 081). The value is displayed in °C.	r58	Cmp.CtrlSens
<b>Compressor capacity</b>		<b>Compressor pack config.</b>
<b>Running time</b>		
To prevent frequent start/stop, values have to be set for how the relays are to cut in and out.		
Min. ON time for relays. (The time is not used if the relay cuts an unloader in or out).	c01	Min.ON time
Min. time period between cutin of same relay. (The time is not used if the relay cuts an unloader in or out).	c07	MinRecyTime
<b>Setting for neutral zone regulation</b>		
Regulation band over the neutral zonen	c10	+ Zone k / + Zone b
Time delay between step cut-ins in the regulation band over the neutral zone	c11	+ Zone m
Time delay between step cut-ins in the regulation band over the "+Zone band".	c12	++ Zone m
Regulation band under the neutral zone	c13	- Zone k / - Zone b
Time delay between step cut-outs in the regulation band under the neutral zone	c14	- Zone m
Time delay between step cut-outs in the regulation band under the "-Zone band"	c15	-- Zone m
<b>Pump down limit</b> The factory setting for this function is OFF. Activate by setting a value corresponding to pressure under the zone and over the P0 min. limit. The function keeps the last capacity step going until the pressure comes down to the pump down limit. When this value is reached the last compressor will cut out. Do not reconnect capacity until the pressure is once more above the neutral zone.	c33	PumpDownLim.
<b>Compressor configuration</b> This setting only applies if "061" is set to "1" or "2". Here you set the predefined combination of number of compressors and any unloaders. <b>1</b> = One compressor, <b>2</b> = two compressors, <b>3</b> = three, <b>4</b> = four. <b>5</b> = One compressor + one unloader. <b>6</b> = One compressor + two unloaders. For <b>7</b> to <b>26</b> : See survey on page 11 If the compressors are of different sizes the setting must be selected to either 4 or 0. At pos. 0 it is up to you to determine which relays have to be drawn on at each of the required capacity steps.	c16	Compr mode
<b>Selection of coupling mode</b> (See also the overview page 11) 1. Sequential: First relay 1 cuts in, then relay 2, etc. Cutout takes place in the opposite sequence. ("First in, last out"). 2. Cyclic: An automatic operating time equalisation is arranged here, so that all steps with motor connection will have the same operating time 3. Binary and cyclic (only for four compressors with "c16" set to 4.	c08	Step mode
<b>Unloaders' cutin and cutout mode</b> The relays for unloaders can be set to switch on when more capacity is required (setting = 0), or they can switch off when more capacity is called for (setting = 1).	c09	Unloader (switch on = 0) (switch off = 1)

<p><b>Mix and Match step 1.</b> This function cuts the relay in and out depending on the definitions in "c17" to "c28". ("c17" to "c28" only used, if "o61" selected to "3" or "4"). (In Mix and Match couplings the settings "c08" and "c09" are not used).</p> <p><b>Step 1</b> Here in c17 set the relays to be ON at step 1. Setting takes place with a numerical value representing the combination of relays. See the survey page 11. Proceed by defining steps two, three, etc. The definition ends at the first c18 - c28 which is set to "0". The time delays "c01" and "c07" belong to the individual relay outputs. If a relay output is captured by the time delay, a changeover from one step to another will only take place when all the relay outputs concerned have been released. The time delay will not interfere with a relay which is ON in two successive couplings. If a compressor drops out there will be an alarm. The regulation will continue as emergency operation, as if the compressor were present.</p> <p><b>Step 2.</b> Here you also set a value between 1 and 15. Here in c18 the value will indicate which relays have to be ON at step 2.</p> <p><b>Step 3.</b> etc.</p> <p><b>4.</b> Etc.</p> <p><b>5.</b></p> <p><b>6.</b></p> <p><b>7.</b></p> <p><b>8.</b></p> <p><b>9.</b></p> <p><b>10.</b></p> <p><b>11.</b></p> <p><b>12.</b></p>	c17	M&M Step 1
	c18	M&M Step 2
	c19	M&M Step 3
	c20	M&M Step 4
	c21	M&M Step 5
	c22	M&M Step 6
	c23	M&M Step 7
	c24	M&M Step 8
	c25	M&M Step 9
	c26	M&M Step 10
	c27	M&M Step 11
	c28	M&M Step 12
<p><b>Manual control of compressor capacity</b> This sets the capacity that is to be cut in when switching to manual control. (c01 and c07 will still apply)</p>	c31	CmpManCap%
<p><b>Manual control</b> Manual control of the compressor capacity is enabled here. When set to ON, the capacity that is set in "c31" is cut in.</p>	c32	CmpManCap
	-	--- Comp. Cap % Read cut-in compressor capacity
		Actual zone state: 0=off. 1=-zone. 2=-zone. 3=Neutral-zone. 4=+zone. 5=++zone
<b>Condenser capacity</b>		
<p><b>Definition of condenser and number of fans</b> Here you set the number of fan steps with which regulation has to be carried out (but max. eight). <b>1-8:</b> All fans are cut in and out with relays. The first vacant relay number is assigned to fan 1, the next to number 2, etc. Steps after DO8 must be executed through connection of a relay module type EKC 331 to the analog output. Cf. drawing on page 12. <b>9:</b> All fans controlled via the analog output and a frequency converter. <b>10:</b> Not used <b>11-18:</b> Total number of fan relays (as 1-8), but here the starting sequence is altered after each time all fans are stopped.</p>	c29	Fan mode
<p><b>Read temperature at sensor Sc3</b></p>	u44	Sc3 temp
<p><b>Read temperature at sensor Sc4</b> (sensor is only used for monitoring)</p>	u45	Sc4 temp
	-	--- Fan Cap % Read cut-in condenser capacity
<b>Regulation parameters for the condenser regulation</b>		
<p><b>Proportional band xp (P = 100/Xp)</b> If the Xp value is increased, the regulation becomes steadier</p>	n04	Xp K
<p><b>I: Integration time Tn</b> If the Tn value is increased, the regulation becomes steadier</p>	n05	Tn s
<p><b>Manual control of condenser capacity</b> This sets the capacity that is to be cut in when switching to manual control.</p>	n52	FanManCap%
<p><b>Manual control</b> Manual control of the condenser capacity is enabled here. When set to ON, the capacity that is specified in "n52" is cut in.</p>	n53	FanManCap
<p><b>Speed control start value</b> Speed control will only be activated when the capacity requirement reaches this value.</p>	n54	StartSpeed
<p><b>Speed control stop value</b> Speed control will be stopped when the capacity requirement falls below this value.</p>	n55	MinSpeed

Alarm		Alarm settings
The controller can give alarm in different situations. When there is an alarm the light-emitting diodes (LED) will flash on the display and the alarm relay will cut in. (In AK-PC 530 the alarm relay may be used for a fan, if required).		
<b>P0 min.</b> (Alarm and safety function, see also page 20.) Here you set when the alarm at too low suction pressure is to enter into effect. The value is set as an absolute value.	A11	Min. P0. b
<b>Alarm delay P0 alarm</b> The time delay is set in minutes. At min. setting the alarm is cancelled.	A44	P0AlrmDelay
<b>Pc max.</b> (Alarm and safety function, see also page 20.) Here you set when the alarm at too high condensing pressure is to enter into effect. The value is set as an absolute value.	A30	Max. Pc. b
<b>Alarm delay Pc alarm</b> The time delay is set in minutes. At min. setting the alarm is cancelled.	A45	PcAlrmDelay
<b>Alarm delay DI1 (an interrupted input will give alarm).</b> The time delay is set in minutes. At max. setting the alarm is cancelled.	A27	DI1AlrmDelay
<b>Alarm delay DI2 (an interrupted input will give alarm).</b> The time delay is set in minutes. At max. setting the alarm is cancelled.	A28	DI2AlrmDelay
<b>Alarm delay DI3 (an interrupted input will give alarm).</b> The time delay is set in minutes. At max. setting the alarm is cancelled.	A29	DI3AlrmDelay
<b>Alarm limit for high temperature of the "Saux1" sensor</b> With setting = Off the alarm has been opted out.	A32	Saux1 high
<b>Alarm delay from "Saux1" (A32)</b> If the limit value is exceeded, a timer function will commence. The alarm will not become active until the set time delay has been passed. The time delay is set in minutes.	A03	Alarm delay
Give the top button a brief push to zeroset the alarm and to have the message shown on the display.		Reset alarm The function zerosets all alarms when set in pos. ON.
		With data communication the importance of the individual alarms can be defined. Setting is carried out in the "Alarm destinations" menu.

Miscellaneous		Miscellaneous
<b>Choice of application</b> The regulator can be configured in various ways. The use that is required out of the four uses available is set here. The functions for the four uses can be viewed on page 14. <i>This menu must be set as the first of all menus, as it enables the associated settings to be set.</i> 1. Show temperature and "c16" mode 2. Show pressure and "c16" mode 3. Show temperature and M&M mode 4. Show pressure and M&M mode	o61	This setting cannot be made via data communication. It must be set directly on the controller.
<b>Sensor type</b> (Sc3, Sc4 and "Saux1") (see also overview page 21) Normally a Pt1000 sensor with great signal accuracy is used for temperature measurement and AKS 32R for pressure measurement. But a PTC sensor may also be used (r25 = 1000) in special situations. All temperature sensors must be of the same kind. In brine cooling the pressure measurements are replaced by temperature measurements. The following settings are possible: <b>0</b> =PT1000. <b>1</b> =PTC1000. <b>2</b> =PT1000 on sensors and on Po. <b>3</b> =PTC1000 on sensors and on Po. <b>4</b> =PT1000 on sensors and on Pc. <b>5</b> =PTC1000 on sensors and on Pc. <b>6</b> =PT1000 on sensors, on Po and on Pc. <b>7</b> =PTC1000 on sensors, on Po and on Pc. (If a temperature sensor is mounted on P0 or Pc, the respective settings in o20, 21, 47 and 48 will not be required).	o06	Sensor type
<b>Settings at water cooler application</b> Definition of the signal inlet when compressor regulation is controlled with signal from a temperature sensor: 0. Temperature signal on terminal 57-58 (P0 inlet) 1. Temperature signal on Saux inlet 2. Temperature signal on Sc4 inlet (P0 min. function (A11) will not be affected by the definition) If frost protection is required, you must connect a pressure transmitter on P0 and the temperature sensor must be connected to the Saux or Sc4 input. Select 1 or 2 at plants where there is no need for frost protection, the alarm "E2" can be suppressed by connecting the signal from the PC (terminal 61) to P0 (terminal 58).	o81	Ctrl.Sensor

<b>Display connection</b> This is where you define the type of display that is connected to the controller Off: EKA 164 On: EKA 165. The extended display with LEDs.	o82	
<b>Read temperature at sensor "Saux1"</b>	o49	Saux1 temp
<b>Pressure transmitter's working range</b> Depending on the pressure, a pressure transmitter with a given working range is used. This working range must be set in the controller (e.g.: -1 to 12 bar The values must be set in bar if display in °C has been selected. And in psig, if °F has been selected.		If the values are to be set from the AKM programme, they must be set in bar.
P0-Min. value	o20	P0MinTrsPres
P0-Max. value	o21	P0MaxTrsPres
Pc-Min. value	o47	PcMinTrsPres
Pc-Max. value	o48	PcMaxTrsPres
<b>Use of DI1 input</b> The digital input can be connected to a contact function, and the contact can now be used for one of the following functions: Setting / function: <b>0:</b> DI input not used <b>1:</b> Fan alarm when contact cuts out. Alarm "A34" is given. <b>2:</b> Alarm function when the contact cuts out. Alarm "A28" is given. There is time delay for the alarm. Setting in "A27".	o78	Di1 control
<b>Use of DI4 input</b> The digital input can be connected to a contact function, and the contact can now be used for one of the following functions: Setting / function: <b>0:</b> DI input not used <b>1:</b> Regulation reference P0 displaced when contact is cut in <b>2:</b> Alarm function when the contact cuts out. Alarm "A31" is given. There is no time delay.	o22	Di4 control
<b>Use of DI5 input</b> The digital input can be connected to a contact function, and the contact can now be used for one of the following functions: Setting / function: <b>0:</b> DI input not used <b>1:</b> Regulation reference Pc displaced when contact is cut in <b>2:</b> Alarm function when the contact cuts out. Alarm "A32" is given. There is no time delay	o37	Di5 control
<b>Operating hours</b> The operating hours for the compressor relays can be read and set in the following menus. The read value is multiplied by 1000 to obtain the number of hours (f.ex. shows 2.1 for 2100 hours). On reaching 99.9 hours the counter stops and must now be reset to, say, 0. There will be no alarm or error message for counter overflow.		(In the AKM display the hour number has not been multiplied)
Value for relay number 1 to 4	o23- o26	DO1 run hour.... DO4 run hour
Value for relay number 5 to 8	o50- o53	DO5 run hour ..... DO8 run hour
<b>Refrigerant setting</b> Before refrigeration is started, the refrigeration must be defined. You may choose between the following refrigerants: 1=R12. 2=R22. 3=R134a. 4=R502. 5=R717. 6=R13. 7=R13b1. 8=R23. 9=R500. 10=R503. 11=R114. 12=R142b. 13=User defined. 14=R32. 15=R227. 16=R401A. 17=R507. 18=R402A. 19=R404A. 20=R407C. 21=R407A. 22=R407B. 23=R410A. 24=R170. 25=R290. 26=R600. 27=R600a. 28=R744. 29=R1270. 30=R417A. 31=R422A, 32=R413A. 33=R422D. 34=R427A. 35=R438A. Warning: Wrong selection of refrigerant may cause damage to the compressor. Other refrigerants: Select setting 13 here, and subsequently three factors have to be set – fac1, fac2 and fac3 – via AKM.	o30	Refrigerant
<b>Manual control</b> (stopped regulation only) From this menu the relays can be cut in and out manually. <b>0</b> gives no override, but a number between 1 and 10 will cut in a belonging relay. <b>1</b> will cut in relay number 1, <b>2</b> relay 2, etc. <b>11-18</b> will produce voltage on the analog output. In this way the relays on the external relay module can be activated. Setting <b>11</b> will give a voltage of 1.25 V, setting <b>12</b> will give 2.5 V, etc.	o18	---
<b>Frequency</b> Set the net frequency.	o12	50 / 60 Hz (50=0, 60=1)



<b>Address</b> If the controller is built into a network with data communication, it must have an address, and the master gateway of the data communication must then know this address. These settings can only be made when a data communication module has been mounted in the controller and the installation of the data communication cable has been completed. This installation is mentioned in a separate document "RC8AC".		Following installation of a data communication module, the controller can be operated on a par with the other controllers in ADAP-KOOL® refrigeration controls.
The address is set between 1 and 240 (gateway determined)	o03	
The address is sent to the gateway when the menu is set in pos. ON	o04	
<b>Access code</b> If the settings in the controller are to be protected by a numerical code, you can set a numerical value between 0 and 100. If not, you can cancel the function with setting OFF.	o05	
<b>Special settings</b> Outputs DO9 and DO10 are normally used for the "AKD start/stop" function and for the alarm function, but they may be redefined in special cases.		
DO9 function: 0: AKD Start/stop 1: Inject-on function (see drawing below) 2: Boost ready function (see drawing below) 3: Fan relay (If "c16" is set to 18, "o75" will automatically be set to unloader relay for compressor 3)	o75	DO9 function
DO10 function: 0: Alarm relay 1: Fan relay	o76	DO10 function
<b>Status on the digital inputs</b> The signal on the DI inputs can be read in the following menus:		
Status on DI 1	u10	DI 1 Status
Status on DI 2	u37	DI 2 Status
Status on DI 3	u87	DI 3 Status
Status on DI 4	u88	DI 4 Status
Status on DI 5	u89	DI 5 Status

Configuration settings (compressor and fan definitions, coupling mode and refrigerant) can only take place when regulation is stopped.

**Warning ! Direct start of compressors \***

To prevent compressor breakdown parameter c01 and c07 should be set according to suppliers requirements or in general :

Hermetic Compressors c07 min. 5 minutes

Semihermetic Compressors c07 min. 8 minutes and c01 min. 2 to 5 minutes ( Motor from 5 to 15 KW )

\*) Direct activating of solenoid valves does not require settings different from factory (0)

**DO9 function:**

**Inject-on function**  
 DO9 is here used for the Inject ON function. Here all the electronic expansion valves are closed when all the compressors are **stopped and PO > +Zone**.

Wiring is carried out as shown below.

The function may however also be generated via data communication. In this way the relay output is made available for other applications.

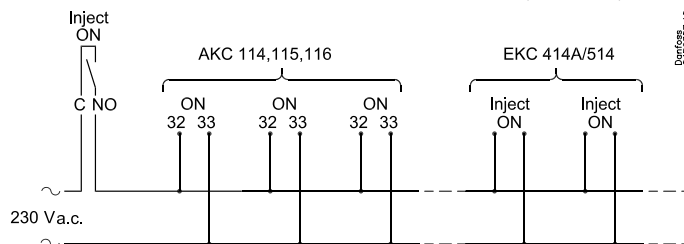

**Boost ready function**

If two controllers are to capacity regulate the high-temperature part and the low-temperature part, respectively, they must be connected in such a way that low-temperature regulation cannot be started until the high-temperature part is operating. The signal can be taken from DO9 of one controller and received on the ON input of the other controller.

Example:

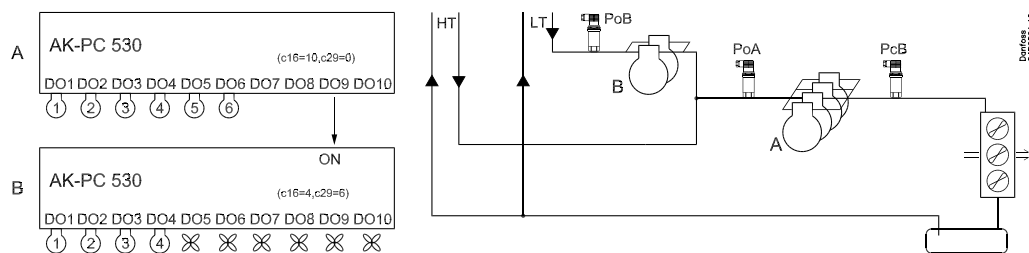

<b>Operating status</b>	
The controller goes through some regulating situations where it is just waiting for the next point of the regulation. To make these "why is nothing happening" situations visible, you can see an operating status on the display. Push briefly (1s) the upper button. If there is a status code, it will be shown on the display. The individual status codes have the following meanings	EKC state
S0: Regulation	0
S2: When the relay is operated, it must be activated for min. x minutes (cf. c01)	2
S5: Renewed cutin of the same relay must not take place more often than every x minutes (cf. c07)	5
S8: The next relay must not cut in until x minutes have elapsed (cf.c11-c12)	8
S9: The next relay must not cut out until x minutes have elapsed (cf. c14-c15)	9
S10: Regulation stopped with the internal og external start/stop	10
S25: Manual regulation of outputs	25
S34: Safety cutout. Setting A30 is exceeded	34
<b>Alarm messages</b>	<b>Alarms "Destinations"</b>
A2: Low P0	A02 Low P0 alarm
A11: No refrigerant has been selected (cf. o30)	A11 No RFG Sel
A17: High Pc	A17 Hi Pc alarm
A19 ....A26: Compr. fault. Interrupted signal on actual input (terminal 29-36)	A19..... A26 Comp_ fault
A27: High temperature alarm for sensor "Saux1"	A27 Saux1 high
A28 .... A32: External alarm. Interrupted signal on input "DI1" /2/3/4/5	A28..... A32 DI_ Alarm
A34: Fan alarm. There is signal on DI1 input	A34 Fan fault
A45: Regulation stopped with setting or with external switch	A45 Stand by
E1: Error in the controller	E1 Ctrl. fault
E2: Control signal outside the range (short-circuited/interrupted) At water cooler management without frost protection may alarm from a not mounted P0 input suppressed by connecting the signal from the PC (terminal 61) to P0 (terminal 58).	E2 Out of range

**Compressor configuration when o61 = 1 or 2** (This is where you can choose between the options shown.)

Setting "c16" will define the configuration.

Setting "c08" will define coupling mode.

Compressor connections										Set "C16" to	Set "C08" to
Relay no.											
1	2	3	4	5	6	7	8	9	10		
1										1	1
1	2									2	1 / 2
1	2	3								3	1 / 2
1	2	3	4							Binary	1 / 2 / 3
1	1a									5	1
1	1a	1b								6	1
1	1a	1b	1c							7	1
1	1a	2	2a							8	1 / 2
1	2	3	4	5						9	1 / 2
1	2	3	4	5	6					10	1 / 2
1	2	3	4	5	6	7				11	1 / 2
1	2	3	4	5	6	7	8			12	1 / 2
1	1a	1b	2	2a	2b					15	1 / 2
1	1a	1b	1c	2	2a	2b	2c			16	1 / 2
1	1a	2	2a	3	3a					17	1 / 2
1	1a	1b	2	2a	2b	3	3a	3b		18	1 / 2
1	1a	2	2a	3	3a	4	4a			19	1 / 2
1	1a	2							4 x 25 %	21	1
1	1a	2	3						6 x 16,6%	22	1 / 2
1	1a	2	3	4					8 x 12,5 %	23	1 / 2
1	1a	1b	2						6 x 16,6 %	24	1
1	1a	1b	2	3					9 x 11 %	25	1 / 2
1	1a	1b	2	3	4				12 x 8,3 %	26	1 / 2

**Capacity step**

All capacity steps are presumed to be identical. The only exception is the settings c16 = 4 and 21 to 26.

**Coupling mode**

Coupling mode 1 = *sequential* operation.  
 Coupling mode 2 = *cyclic* operation.  
 Coupling mode 3 = *cyclic* and binary operation where the compressor capacities are, as follows:

- 1: 9%
- 2: 18%
- 3: 36%
- 4: 36%

There is cyclic coupling at 3 and 4, and binary on 1, 2 and 3/4. (for c16=4 only)

**Couplings**

When there is cyclic operation and connections with unloaders there will in some capacity cutins and cutouts be overlappings where the unloaders from either one compressor or another may be active.

In such cases the unloaders on the compressor with the lowest number of hours will be cut in, and the others cut out.

The changeover will take place at 6-second intervals.

**Equalised operation**

When c16 = 21 to 26, compressor 1 + belonging unloader must have the same capacity as each of the subsequent compressors. The unloading function will equalise the cut-in capacity when the subsequent compressors are cut in and out. Compressor 1 will always be operating.

**Compressor configuration when o61 = 3 or 4** (This is where you must define yourself how the relays are to be activated.)

(Mix and Match used only on plants with up to 4 compressors.)

Survey of relays in Mix and Match operation																
Relay no.	Calculation value	Combination of relays that must be cut in														
1	1	1		1		1		1		1		1		1		
2	2		2	2			2	2			2	2		2		
3	4				4	4	4	4				4	4	4		
4	8								8	8	8	8	8	8		
The sum of 1-8 is the setting value for each step		1	2	3	4	5	6	7	8	9	10	11	12	13	14	15

Example 1

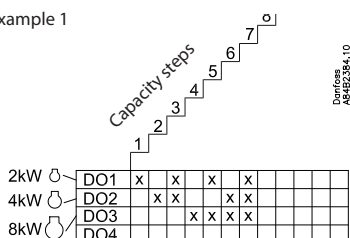

- Settings:
- c17 to 1
  - c18 to 2
  - c19 to 3
  - c20 to 4
  - c21 to 5
  - c22 to 6
  - c23 to 7

Example 2

If capacity step 1 has to cut in relay number 3 only, you must set c17 to 4.  
 If capacity step 2 has to cut in relay number 4 only, you must set c18 to 8.  
 If capacity step 3 has to cut in relay numbers 3 and 4, you must set c19 to 12.  
 Continue with a setting for c20 etc. until all capacity steps have been defined.

### Condenser couplings

When the compressor relays have been established the turn comes to the fan relays. The first vacant relay (DO1-DO8) will become the first fan relay. It will be followed by the subsequent relays. If more relays are required than the vacant DO relays, a relay module can be connected to the analog output. The function is, as follows:

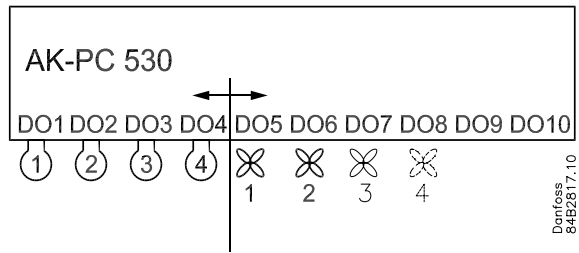

If there are up to four external fans on an EKC 331:

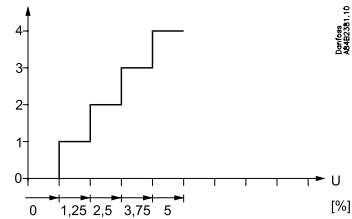

Output signal from AK-PC 530  
 In EKC 331 the voltage range must be set to 0-5 V ("o10" = 6).  
 In EKC 331 the number of steps must be set to 4 ("o19" = 4) (also when fewer fans are connected).

#### Connection

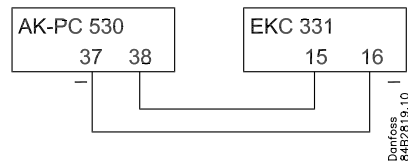

If there are more than four external fans on two EKC 331 units:

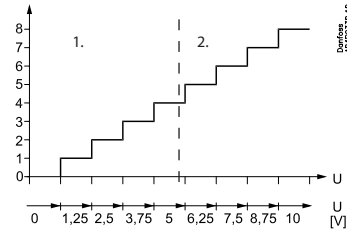

Output signal from AK-PC 530  
 In the first EKC 331, set 0-5 V ("o10" = 6).  
 In the second EKC 331, set 5-10 V ("o10" = 7).  
 In both EKC's the number of steps must be set to 4 ("o19" = 4) (also when fewer fans are connected to the second EKC).

#### Connection

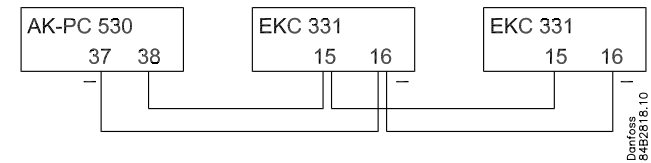

### Alternating start-up of fans (only if c29 is 11 to 18)

The fans can be defined to start alternately when they have all been stopped. The first time regulation is started, fan 1 will be started first – the regulation determines whether additional fans will be started. After the next time all fans are stopped, fan 2 will be the first to be started, and so on. Fan 1 will again be the first fan to be started when the rotation has been through the total number of fans. If there is more than one fan on an EKC 331, it will not be possible to start the other fans first. Here, the fan with the lowest voltage step will **always** be the one which is started first.

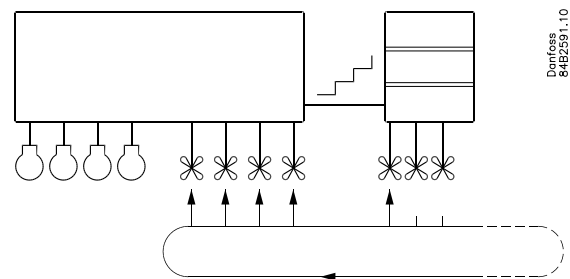

If the entire condenser capacity is to be controlled by a frequency converter, AK-PC 530 must send an analog signal about the required capacity ("c29" = 9). The signal varies from 0 to 10 V. Signal and capacity have the following context.

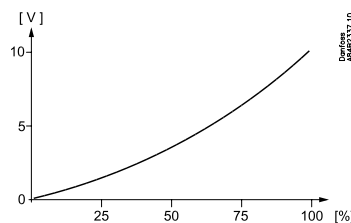

## Operation

### Data communication

If the controller is extended with data communication, the operation can be performed from a system unit. The parameter names for the functions can be viewed in the right-hand column on pages 4–10.

The importance of the alarms that are sent can be defined with the setting: 1 (High), 2 (Medium), 3 (Low) or 0 (No alarm).

### Operation via external display

The values will be shown with three digits, and with a setting you can determine whether the pressures are to be shown in SI units (°C / bar) or US units (°F / psig.).

There are three options for the display.

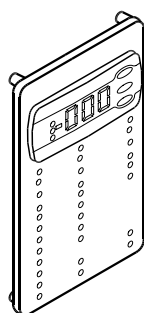

EKA 165

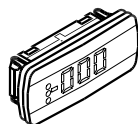

EKA 163

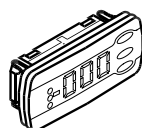

EKA 164

### EKA 165

To operate the controller and view the evaporation pressure. If the lowermost key is pressed, the condensation pressure will be shown briefly in the display. (If regulation is based only on the condensation pressure, the display will always show Pc).

During normal operation the light-emitting diodes in the display will indicate where regulation is taking place.

Highest + second highest	:	++Zone
Second highest	:	+Zone
"None"	:	Neutral zone
Second lowest	:	-Zone
Lowest+ second lowest	:	-- Zone

The other LEDs on the display will show the functions that are active:

- Relays for compressors
- Relays for fans
- Input signals for the digital inputs
- The optimization LED will light up when the reference is 2 K or more over the set point.

### EKA 163

If the condensation pressure is to be shown constantly, a display without operating keys can be connected.

### EKA 164

To operate the controller and view the evaporation pressure. If the lowermost key is pressed, the condensation pressure will be shown briefly in the display.

Like the EKA 165, the LEDs in the display will show where the regulation is located.

### The buttons on the display

When you want to change a setting, the upper and the lower buttons will give you a higher or lower value depending on the button you are pushing. But before you change the value, you must have access to the menu. You obtain this by pushing the upper button for a couple of seconds - you will then enter the column with parameter codes. Find the parameter code you want to change and push the middle button. When you have changed the value, save the new value by once more pushing the middle button.

Or short:

1. Push the upper button (long push) until a parameter is shown
2. Push one of the buttons and find the parameter you want to change
3. Push the middle button until the setting value is shown
4. Push one of the buttons and select the new value
5. Push the middle button again to conclude the setting

(A brief pushing will show the active alarm codes. See page 17.)

## Menu survey

### Sequence

- o61 must be set as the first parameter. This parameter determines which of the four operating interfaces (application mode) are activated. This must be set via the display keys. It cannot be set via data communication. (Active functions are shown below in shaded fields.)
- Quick- start  
To get the system up and running quickly so that cooling can be commenced, start it by setting the following parameters (these parameters can only be set when the regulation is stopped, r12=0):  
r23, r28 and then either (c08, c09 and c16) or (c17 to 28) – continue with c29, o06, o30, o75, o76, o81 **and finally r12=1.**
- Once the regulation is under way, you can go through the other parameters and adjust them in situ.

SW: 1.3x

Function	Parameter	o61 =				Min.	Max.	Factory setting
		1	2	3	4			
<b>Normal display</b>								
Shows P0 in EKA 165 (display with buttons)	-	°C	P	°C	P	°C / bar		
Shows Pc in EKA 163	-	°C	P	°C	P	°C / bar		
<b>P0 reference</b>								
Neutral zone	r01					0.1°C / 0.1 bar	20°C / 5.0 bar	4.0°C / 0.4 bar
Correction of signal from P0 sensor	r04					-50°C / -5.0 bar	50°C / 5.0 bar	0.0
Select view; SI or US. 0=SI (bar /°C), 1=US (Psig /°F)	r05					0	1	0
Start/Stop of regulation	r12					OFF	ON	OFF
Reference offset for P0 (see also r27)	r13					-50°C / -5.0 bar	50°C / 5.0 bar	0.0
Set regulation setpoint for P0	r23					-99°C / -1 bar	30°C / 60.0 bar	0.0°C / 3.5 bar
Shows total P0 reference ( r23 + various displacements)	r24					°C / bar		
Limitation: P0 reference max. value (also applies to regulation with reference displacement)	r25					-99°C / -1.0 bar	30°C / 60.0 bar	30.0°C / 40.0 bar
Limitation: P0 referencen min. value (also applies to regulation with reference displacement)	r26					-99°C / -1.0 bar	30°C / 40.0 bar	-99.9°C / -1.0 bar
Displacement of P0 (ON=active "r13")	r27					OFF	ON	OFF
<b>Pc reference</b>								
Set regulation setpoint for Pc	r28					-25°C / 0.0 bar	75°C / 110.0 bar	35°C / 15.0 bar
Shows total Pc reference	r29					°C / bar		
Limitation: Pc referencen max. value	r30					-99.9°C / -0.0 bar	99.9°C / 130.0bar	55.0°C / 60.0 bar
Limitation: Pc referencen min. value	r31					-99.9°C / 0.0 bar	99.9°C / 60.0bar	-99.9°C / 0.0 bar
Correction of signal from Pc sensor	r32					-50°C / -5.0 bar	50°C / 5.0 bar	0.0
Pc reference variation. 1 and 2 are PI-regulation 1: Fixed reference. "r28" is used 2: Variable reference. Outdoor temperature (Sc3) included in the reference 3: As 1, but with P-regulation (Xp-band) 4: As 2, but with P-regulation (Xp-band)	r33					1	4	1
Reference offset for Pc	r34					-50°C / -5.0 bar	50°C / 5.0 bar	0.0
The mean temperature difference across the condenser at maximum load (dim tm K)	r35					3.0	50.0	10.0
The mean temperature difference across the condenser at the lowest relevant compressor capacity (min tm K)	r56					3.0	50.0	8.0
This is where you can see the actual pressure (P0) that is being measured by the pressure transmitter.	r57					°C / bar		
This is where you can see the actual pressure (T0) that is part of the regulation. From the sensor which is defined in "o81"	r58					°C		
<b>Capacity</b>								
Min. ON time for relays	c01					0 min	30 min.	0
Min. time period between cutins of same relay	c07					0 min.	60 min	4
Definition of regulation mode 1: Sequential (step mode / FILO) 2: Cyclic (step mode / FIFO) 3: Binary and cyclic	c08					1	3	1
If a regulation mode with unloaders is selected, the relay must be defined to: 0: Cut in when more capacity is required 1: Cut out when more capacity is required	c09					0	1	0
Regulation parameter for + Zone	c10					0.1 K / 0.1 bar	20 K / 2.0 bar	4.0 / 0.4 bar

To be continued

Regulation parameter for + Zone	c11					0.1 min	60 min	4.0
Regulation parameter for ++ Zone	c12					0.1 min.	20 min	2.0
Regulation parameter for - Zone	c13					0.1 K / 0.1 bar	20 K / 2.0 bar	4.0 / 0.3 bar
Regulation parameter for - Zone	c14					0.1 min.	60 min	1.0
Regulation parameter for - - Zone	c15					0.02 min.	20 min	0.5
Definition of compressor connections. See options on page 11.	c16					1	26	0
<i>Following "c17" to "c28" is another way to define compressor than with "c16". A code will then have to be set for the relays that are to be ON at the different steps:</i> Step 1 (M&M operation)	c17					0	15	0
Step 2 (M&M operation)	c18					0	15	0
Step 3 (M&M operation)	c19					0	15	0
Step 4 (M&M operation)	c20					0	15	0
Step 5 (M&M operation)	c21					0	15	0
Step 6 (M&M operation)	c22					0	15	0
Step 7 (M&M operation)	c23					0	15	0
Step 8 (M&M operation)	c24					0	15	0
Step 9 (M&M operation)	c25					0	15	0
Step 10 (M&M operation)	c26					0	15	0
Step 11 (M&M operation)	c27					0	15	0
Step 12 (M&M operation)	c28					0	15	0
Definition of condenser: <b>1-8:</b> Total number of fan relays or voltage step on the voltage output <b>9:</b> Only via analog output and start of frequency converter <b>10:</b> Not used <b>11- 18:</b> Total number of fan relays which are to be connected with alternating start-up.	c29					0/OFF	18	0
Cut in compressor capacity with manual control. See also "c32"	c31					0%	100%	0
Manual control of compressor capacity (when ON, the value in "c31" will be used)	c32					OFF	ON	OFF
Pump down limit. Limit value where the last compressor is cut out.	c33					-99.9°C / -1.0 bar	100°C / 60 bar	100°C / 60 bar
Proportional band Xp for (P= 100/Xp) condenser regulation	n04					0.2 K / 0.2 bar	40.0 K / 10.0 bar	10.0 K / 3.0 bar
I: Integration time Tn for condenser regulation	n05					30 s	600 s	150
Cutin condenser capacity with manual control. See also "n53"	n52					0%	100%	0
Manual control of condenser capacity (when ON, the value in "n52" will be used)	n53					OFF	ON	OFF
Start speed The voltage for the speed regulation is kept at 0V until the regulation requires a higher value than the value set here.	n54					0%	75%	20%
Min. speed. The voltage for the speed regulation switches to 0V when the regulation requires a lower value than the value set here.	n55					0%	50%	10%
<b>Alarm</b>								
Delay time for a A32 alarm	A03					0 min.	90 min.	0 min.
Low alarm and safety limit for P0	A11					-99°C / -1.0 bar	30°C / 40 bar	-40°C / 0.5 bar
Delay time for a DI1 alarm	A27					0 min. (-1=OFF)	999 min.	OFF
Delay time for a DI2 alarm	A28					0 min. (-1=OFF)	999 min.	OFF
Delay time for a DI3 alarm	A29					0 min. (-1=OFF)	999 min.	OFF
Upper alarm and safety limit for Pc	A30					-10 °C / 0.0 bar	200°C / 200.0bar	60.0°C / 60.0 bar
Upper alarm limit for sensor "Saux1"	A32					1°C (0=OFF)	140°C	OFF
Delay time for a P0 alarm	A44					0 min. (-1=OFF)	999 min.	0 min.
Delay time for a Pc alarm	A45					0 min. (-1=OFF)	999 min.	0 min.
<b>Miscellaneous</b>								
Controllers address	o03*					1	990	
On/off switch (service-pin message)	o04*					-	-	
Access code	o05					1 (0=OFF)	100	OFF

\* this setting is only possible if data communication module is mounted in the controller

Used sensor type for Sc3, Sc4 and "Saux1" 0=PT1000, 1=PTC1000 2-7=variations with temperature sensor on P0 and Pc. See earlier in the manual and page 21.	o06					0	7 (1)	0
Set supply voltage frequency	o12					50 Hz	60 H	0
Manual control of outputs: 0: No override 1-10: 1 will cut in relay 1, 2 relay 2, etc. 11-18: Gives voltage signal on the analog output. (11 gives 1.25 V, and so on in steps of 1.25 V)	o18					0	18	0
P0 pressure transmitter's working range - min. value	o20					-1 bar	0 bar	-1.0
P0 pressure transmitter's working range - max. value	o21					1 bar	200 bar	12.0
Use of DI4-input 0=not used. 1=P0 displacement. 2=alarm function. Alarm="A31"	o22					0	2	0
Operating hours of relay 1 (value time 1000)	o23					0.0 h	99.9 h	0.0
Operating hours of relay 2 (value time 1000)	o24					0.0 h	99.9 h	0.0
Operating hours of relay 3 (value time 1000)	o25					0.0 h	99.9 h	0.0
Operating hours of relay 4 (value time 1000)	o26					0.0 h	99.9 h	0.0
Setting of refrigerant 1=R12. 2=R22. 3=R134a. 4=R502. 5=R717. 6=R13. 7=R13b1. 8=R23. 9=R500. 10=R503. 11=R114. 12=R142b. 13=User defined. 14=R32. 15=R227. 16=R401A. 17=R507. 18=R402A. 19=R404A. 20=R407C. 21=R407A. 22=R407B. 23=R410A. 24=R170. 25=R290. 26=R600. 27=R600a. 28=R744. 29=R1270. 30=R417A. 31=R422A, 32=R413A. 33=R422D. 34=R427A. 35=R438A.	o30					0	35	0
Use of DI5-input 0=not used. 1=Pc displacment. 2=alarm function. Alarm="A32"	o37					0	2	0
Pc pressure transmitter's working range - min. value	o47					-1 bar	0 bar	-1.0
Pc pressure transmitter's working range - max. value	o48					1 bar	200 bar	34.0
Read temperature at sensor "Saux1"	o49							°C
Operating hours of relay 5 (value time 1000)	o50					0.0 h	99.9 h	0.0
Operating hours of relay 6 (value time 1000)	o51					0.0 h	99.9 h	0.0
Operating hours of relay 7 (value time 1000)	o52					0.0 h	99.9 h	0.0
Operating hours of relay 8 (value time 1000)	o53					0.0 h	99.9 h	0.0
Selection of application 1. Show temperature and "c16" mode 2. Show pressure and "c16" mode 3. Show temperature and M&M mode 4. Show pressure and M&M mode	o61	1	2	3	4	1	4	1
Function for relay output DO9: 0. Start / stop of speed regulation 1. Inject on signal for evaporator control 2. Boost ready (at least one compressor is on) 3. Start /stop of condenser fan	o75					0	3	0
Function for relay output DO10: 0. Alarm relay 1. Start / stop of condenser fan	o76					0	1	0
Definition of alarm message at DI1 signal: 0. Not used 1. Fan failure (A34) 2. DI1 alarm (A28)	o78					0	2	0
Settings at water cooler application Definition of signal input to the compressor regulation when regulation with temperature signal: 0. Temperature sensor on 57-58 1. Temperature sensor on Saux 2. Temperature sensor on Sc4 If frost protection is required, the setting must be 1 or 2 and a pressure transmitter has to be mounted on P0	o81					0	2	0
Display connection Off: EKA 164 On: EKA 165 (extended display with light-emitting diodes)	o82					Off	On	Off



Service					
Status on DI1 input	u10				
Status on DI2 input	u37				
Read temperature at sensor "Sc3"	u44				°C
Read temperature at sensor "Sc4"	u45				°C
Status on DI3 input	u87				
Status on DI4 input	u88				
Status on DI5 input	u89				

The controller can give the following messages			
E1	<b>Error message</b>	Fault in controller	
E2		Regulation is outside the range, or the control signal is defective *	
A2	<b>Alarm message</b>	Low P0	
A11		Refrigerant not selected	
A17		High Pc	
A19		Compressor 1 error	The actual compressors safety circuit is interrupted. That is to say the signal is missing on one of the terminals 29-36
A20		Compressor 2 error	
A21		Compressor 3 error	
A22		Compressor 4 error	
A23		Compressor 5 error	
A24		Compressor 6 error	
A25		Compressor 7 error	
A26		Compressor 8 error	
A27		Room temperature alarm (Saux1 temp.)	
A28		DI 1 alarm. Terminal 46 interrupted	
A29		DI 2 alarm. Terminal 47 interrupted	
A30		DI 3 alarm. Terminal 49 interrupted	
A31	DI 4 alarm. Terminal 50 interrupted		
A32	DI 5 alarm. Terminal 52 interrupted		
A34	Fan alarm. There is no signal on DI1 input		
A45	Regulation stopped		
S0	<b>Status message</b>	Regulation	
S2		Wait for "c01"	
S5		Wait for "c07"	
S8		Wait for "c11" or "c12"	
S9		Wait for "c14" or "c15"	
S10		Refrigeration stopped by the internal or external start/stop function	
S25		Manual control of outputs	
S34	Safety cutout. Setting A30 is exceeded or all safety inputs (29-36) are open		
PS	<b>Info</b>	Access code is required before you have access to the settings	

\* At water cooler management without frost protection may alarm from a not mounted P0 input suppressed by connecting the signal from the PC (terminal 61) to P0 (terminal 58).

Messages can be brought up on the display by briefly pressing the uppermost key. If there is more than one alarm, they can be scrolled through

#### Factory setting

If you need to return to the factory-set values, it can be done in this way:

- Cut out the supply voltage to the controller
- Keep the middle button pressed at the same time as you reconnect the supply voltage

## Connections

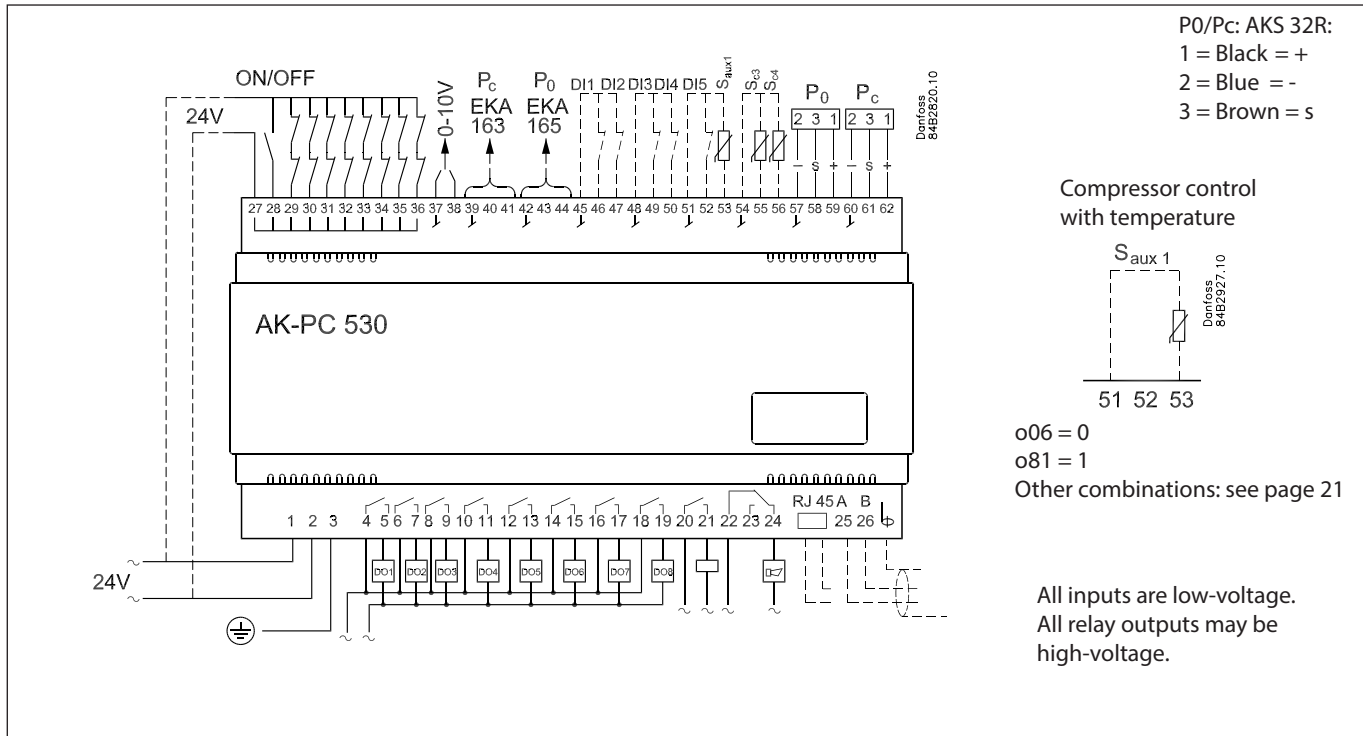

### Necessary connections

#### Terminals:

- 1-2 Supply voltage 24 V a.c.
- 4- 19 Relay outputs for either compressors, unloaders or fan motors
- 22-24 Alarm relay \*  
There is connection between 22 and 24 in alarm situations and when the controller is dead
- 27-28 24 V signal to start / stop of regulation
- 27-29 24 V signal from the safety circuit DO 1
- 27-30 24 V signal from the safety circuit DO 2
- 27-31 24 V signal from the safety circuit DO 3
- 27-32 24 V signal from the safety circuit DO 4
- 27-33 24 V signal from the safety circuit DO 5
- 27-34 24 V signal from the safety circuit DO 6
- 27-35 24 V signal from the safety circuit DO 7
- 27-36 24 V signal from the safety circuit DO 8
- 57-59 Suction pressure. Voltage signal from AKS 32R \*\*
- 60-62 Condenser pressure. Voltage signal from AKS 32R \*\*

### Application dependent connections

- 20-21 AKD start/stop \*  
The relay cutin when the frequency converter have to start.
- 37-38 Voltage signal to external condenser control (see settings page 12)
- 39-41 Possibility of connecting an external display type EKA 163 or display of Pc
- 42-44 Possibility of connecting an external display type EKA 163 for display of P0, or EKA 165 for operation and display of P0
- 45-46 DI1 - Contact function for alarm signal
- 45-47 DI2 - Contact function for alarm signal
- 48-49 DI3 - Contact function for alarm signal
- 48-50 DI4 - Contact function for displacement of the suction pressure reference or for alarm signal.
- 51-52 DI5 - Contact function for displacement of the condenser pressure reference or for alarm signal.
- 51-53 Separate sensor Saux1. Sensor signal from AKS 11, AKS 12 or EKS 111
- 54-55 Out temperature (Sc3). Sensor signal from AKS 11, AKS 12 or EKS 111 (mounted if r33 =2 or 4)
- 54-56 Air temperature at condenser outlet. Sensor signal from AKS 11, AKS 12 or EKS 111

### Unloader

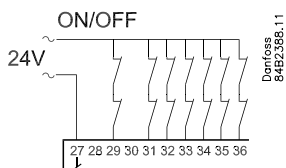

If an output is used for an unloader it is not necessary to wire the belonging safety circuit.  
Ex. with an unloader on DO2 a connection on terminal 30 can be left out

### Data communication

- 25-26 Mount only, if a data communication module has been mounted.  
For ethernet communication the plug connection RJ45 must be used. (LON FTT10 can also be connected in this way.  
It is important that the installation of the data communication cable be done correctly. Cf. separate literature No. RC8AC.

\*) Relays DO9 and DO10 may in special cases be reconfigured so that they can be used as fan relays. See also page 9.

\*\*) • If the controller has to control only the compressor or the fans, respectively Pc and P0 sensor can be dispensed  
• In brine systems temperature measurement at terminals 57-58 and 60-61 may be used instead of pressure measurement with AKS 32R. See also o06.

## Data

Supply voltage	24 V a.c. +/-15% 50/60 Hz, 5 VA	
Input signal	2 pcs. Pressure transmitters type AKS 32R (temperature sensor in brine systems)	
	3 pcs. temperature sensor input for PT 1000 ohm/0°C or PTC 1000 ohm/25°C	
Digitale input from contact function.	1 pcs. for Start/stop of regulation	
	8 pcs. for monitoring of safety circuits	
	3 pcs. for alarm function	
	2 pcs. for alarm function or for displacement of references	
Relay output for capacity regulation	8 pcs. SPST	AC-1: 3 A (ohmic) AC-15: 2 A (inductive)
"AKD start/stop" relay	1 pcs. SPST	
Alarm relay	1 pcs. SPDT	AC-1: 6 A (ohmic) AC-15: 3 (inductive)
Voltage output	0-10 V d.c. Max. 5 mA, Ri min. 2.2 kohm	
Display outputs	EKA 163	Pc display
	EKA 165(164)	Operation, P0 display and LED
Data communication	Possible to connect a data communication module	
Environments	0 - 55°C, during operation	
	-40 - 70°C, during transport	
	20 - 80% Rh, not condensing	
	No shock influence / vibrations	
Enclosure	IP 20	
Weight	0.4 kg	
Mounting	DIN rail or on wall	
Terminals	max. 2.5 mm <sup>2</sup> multicore	
Approvals	EU Low voltage Directive and EMC demands re CE-marking complied with. LVD-tested acc. to EN 60730-1 and EN 60730-2-9 EMC-tested acc. to EN61000-6-2 and 3	

### Pressure transmitter / temperature sensor

Please refer to catalogue RK0YG...

### Installation considerations

Accidental damage, poor installation, or site conditions, can give rise to malfunctions of the control system, and ultimately lead to a plant breakdown.

Every possible safeguard is incorporated into our products to prevent this. However, a wrong installation, for example, could still present problems. Electronic controls are no substitute for normal, good engineering practice.

Danfoss will not be responsible for any goods, or plant components, damaged as a result of the above defects. It is the installer's responsibility to check the installation thoroughly, and to fit the necessary safety devices.

Special reference is made to the necessity of signals to the controller when the compressor is stopped and to the need of liquid receivers before the compressors.

Your local Danfoss agent will be pleased to assist with further advice, etc.

## Ordering

Type	Function	Code no.
AK-PC 530	Capacity controller	<b>084B8007</b>
EKA 163B	Display unit	<b>084B8574</b>
EKA 164B	Display unit with operation buttons	<b>084B8575</b>
EKA 165	Display unit with operation buttons and light-emitting diodes for input and output	<b>084B8573</b>
	Cable for display unit 2 m, 1 pcs.	<b>084B7298</b>
	Cable for display unit 6 m, 1 pcs.	<b>084B7299</b>
EKA 175	Data communication module, RS 485	<b>084B8579</b>
EKA 178B	Data communication module, MOD-bus	<b>084B8571</b>
EKA 174	Data communication module, LON RS 485, with galvanic separation (recommended when output 0-10 V is used)	<b>084B7124</b>

## Montage

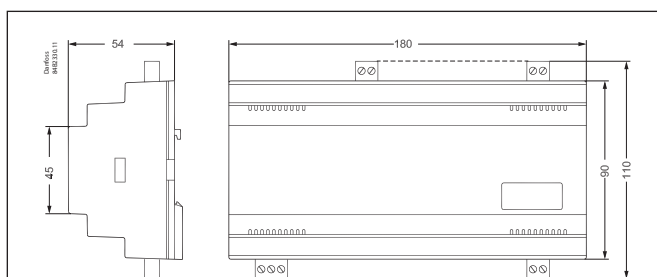

AK-PC 530

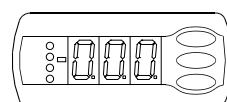
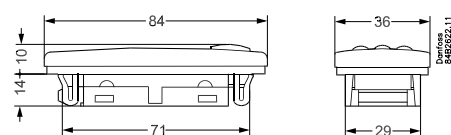

Only for front mounting (IP 40)  
Only connection via plugs

Display type EKA 163 / EKA 164

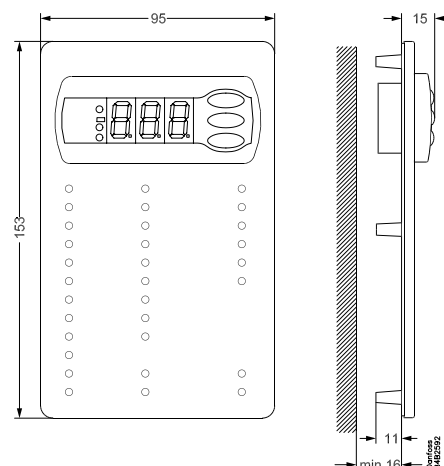

Display type EKA 165

## Safety function

Criterion	Compressor control	Condenser control
P0 < P0 min (A11)	0% capacity. (Min ON time (c01) overridden)	No change
P0 signal failure (P0 reading < 5%)	Calculated average capacity	No change.
Pc > Pc max. minus 3 K (The "HP" LED on EKA 165 lights up)	The capacity changes to 2/3 of the actual capacity. After 30 seconds it changes to half capacity. After a further 30 seconds there is a full cut-out.	100% capacity
Pc > Pc max. (A30)	0% capacity	100% capacity
Pc signal failure (Pc reading < 5%)	No change	100% capacity
Sc3 signal failure (Variable reference (r33) is set to 2 or 4)	No change	The variable part is omitted. Reference (r29) = Setting (r28)
Signal failure on the regulation sensor (Saux or S4. (o81))	The P0 reference lowers by 5 K. At the same time, the P0 signal becomes the regulation sensor	No change

### Exercising fans

On the setting c29 = 1-8 the last fans will hardly be activated during the winter.

To ensure that the fans are 'exercised' a test will be carried out every 24 hours to check whether all relays have been in operation.

The relays that have not been used will now be activated for 30 seconds, but with a pause of one hour between individual relays.

## Override

The controller contains a number of functions that can be used together with the override function in the master gateway. They can therefore only be used in combination with data communication.

Function via data communication	Functions to be used in the system units override function	Selection of parameter in AK-PC 530 084B8007 Sw.1.3x
Stop of injection when the compressor is stopped	AKC ON	--- MC Inject ON
Night setback	Day/night control and time schedule	r27 NightSetback
Suction pressure optimisation	P0 optimisation	Select controller address (The parameters are found automatically and do not become visible).
The system unit registers the refrigeration point which handles the largest capacity (requires the lowest suction pressure). The parameter may be logged for use in a service situation.		--- MLC

## Selecting sensor type and where the signal must be connected

Overview for setting o06

Regulation	P0-input	Pc-input	Sc3**	Sc4	Saux	Setting in o06
Pack/chiller with frost protection + condenser	AKS 32R*	AKS 32R	Pt1000	Pt1000***	Pt1000***	<b>0</b>
			PTC1000	PTC1000***	PTC1000***	<b>1</b>
Chiller without frost protection + condenser	Pt1000	AKS 32R	Pt1000	Pt1000	Pt1000	<b>2</b>
	PTC1000		PTC1000	PTC1000	PTC1000	<b>3</b>
Pack/chiller with frost protection + dry cooler	AKS 32R*	Pt1000	Pt1000	Pt1000***	Pt1000***	<b>4</b>
		PTC1000	PTC1000	PTC1000***	PTC1000***	<b>5</b>
Chiller without frost protection + dry cooler	Pt1000	Pt1000	Pt1000	Pt1000	Pt1000	<b>6</b>
	PTC1000	PTC1000	PTC1000	PTC1000	PTC1000	<b>7</b>

\*) Supplies signal to frost protection.

\*\*) Will supply signal to floating condenser regulation if it is defined in r33 (r33 = 2 or 4).

\*\*\*) With brine cooling where there should also be frost protection, connect the regulation sensor to either Sc4 or Saux (defined in o81).

# Appendix

The regulation functions are explained in more detail below.

## The PC reference

You may choose between four different regulation modes. Basically 1 or 2 are recommended. But if the plant is unstable it may become necessary to change over to 3 or 4.

1. PI regulation. Fixed reference i.e. constant condensing pressure.
2. PI regulation. Floating reference with outdoor temperature i.e. variable condensing pressure.
3. As "1", but with P regulation. A somewhat higher condensing pressure than indicated by the reference must be accepted here.
4. As "2", but with P regulation. A somewhat higher condensing pressure than indicated by the reference must be accepted here.

To limit the variation in the reference, if floating reference is chosen (mode 2 & 4), two limit values will have to be set. A max. limit (r30) and a min. limit (r31). The total regulation reference (r29) will not be able to go beyond these limits.

As a safeguard against too high condenser temperature a Pc max. value (A30) also has to be set. If the temperature approaches this value a cutout of the compressor will be started.

The different regulation modes are as follows:

### 1. PI regulation with fixed reference

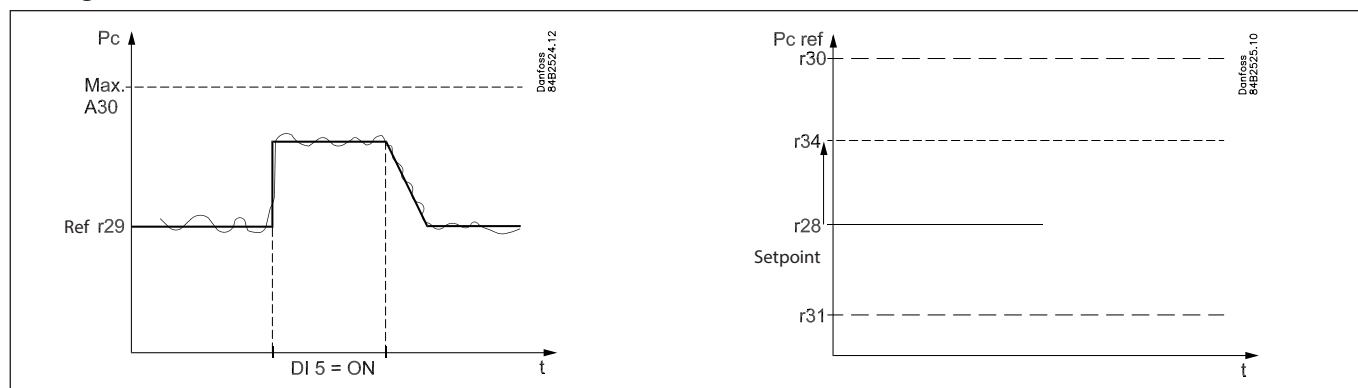

The reference at any time, on the basis of which the controller regulates, can be seen in "r29". A reference (r28) is set here which with certainty can cope with all kinds of loads.

If you need to raise the condensing temperature for, say, heat recovery, an offset value (r34) has to be set. The DI5 function must be defined to 1. When a signal is subsequently received on the DI5 input the reference will be raised.

### 2. PI regulation with floating reference

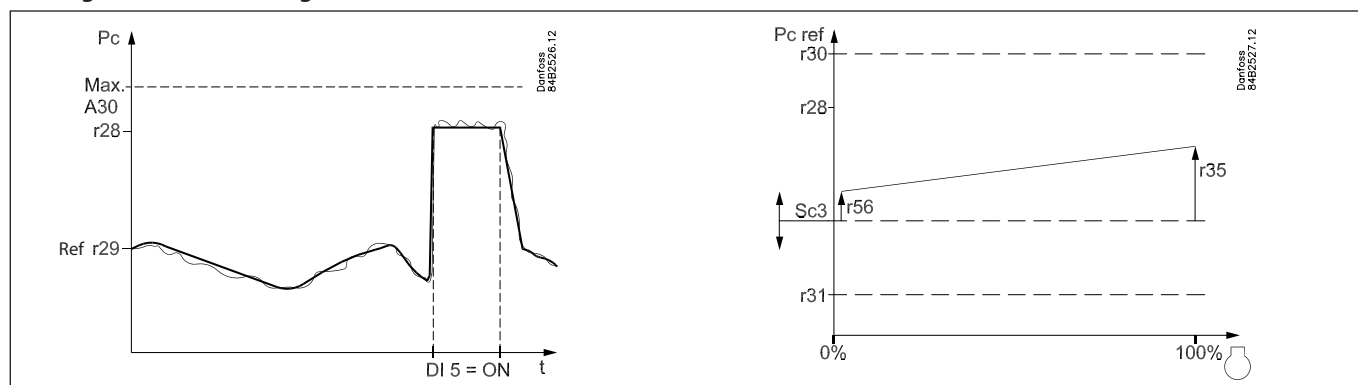

The reference follows the outdoor temperature Sc3. If the outdoor temperature drops one degree the reference will also drop one degree. The reference is adjusted according to the compressor capacity with max. Xp value.

If you need to raise the condensing temperature for, say, heat recovery, the setpoint (r28) must be set to this temperature.

The DI5 function must be defined to 1. When a signal is subsequently received on the DI5 input the reference will be changed to the r28 setting. The reference at any time, on the basis of which the controller regulates, can be seen in "r29". If there is sensor failure on the outdoor temperature sensor the reference will change over to the r28 setting.

### 3. P regulation with fixed setting

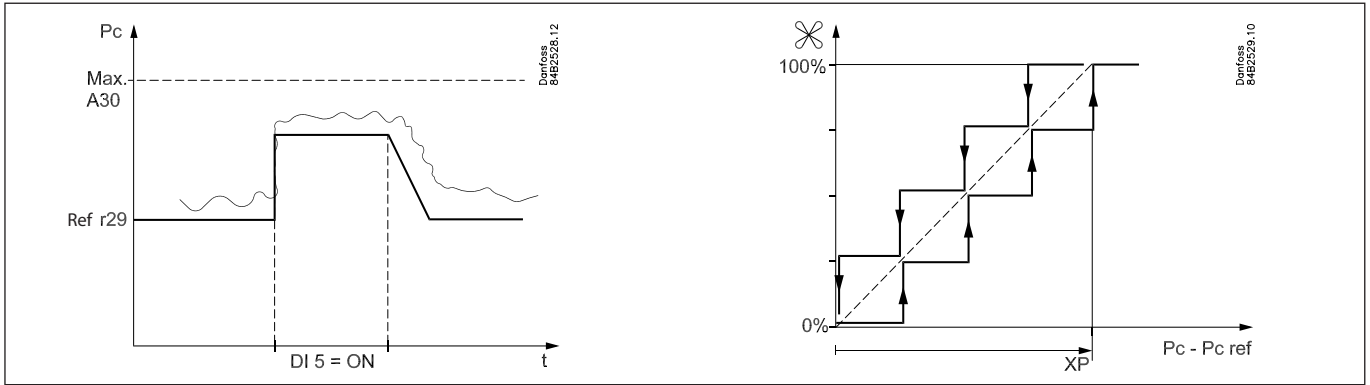

As "1", but an increasing deviation from the reference must be accepted as the controller uses the difference between the actual condenser temperature and the set reference for indicating the number of fans that has to be cut in.

The number of fan steps is divided up based on the Xp value. Recommended setting for Xp is the  $\Delta T$  of the condenser, typically 10 to 15 K. The cutin and cutout of fans are shown in the drawing. If the entire condenser capacity is controlled by speed regulation, the capacity will be indicated on the broken line.

### 4. P regulation with floating reference

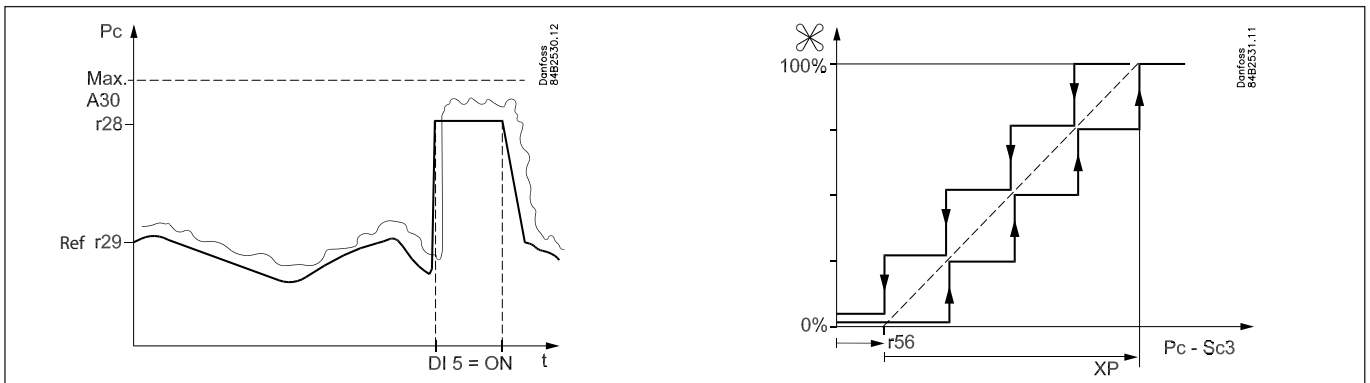

As "2", but an increasing deviation from the reference must be accepted as the controller uses the difference between the actual condenser temperature and the actual outdoor temperature for indicating the number of fans that has to be cut in. (The first "r56-degrees" are left out, as there must be a possibility of cooling via the condenser).

The number of fan steps is divided up based on the Xp value. Recommended setting for Xp is the  $\Delta T$  of the condenser, typically 10 to 15 K. The cutin and cutout of fans are shown in the drawing. If the entire condenser capacity is controlled by speed regulation, the capacity will be indicated on the broken line.

### Important settings for avoiding unwanted alarms

When r33 = 1 or 2:  
Set Pc ref max. to at least 5 K under Pc max. (A30).

When r33 = 3 or 4:  
Set Pc ref max. to at least (Xp value +5) K under Pc max. (A30).

---

## List of literature

Installation guide for extended operation RC8AC--

Here you can see how a data communication connection to ADAP-KOOL® Refrigeration controls can be established.